

# Service Manual

# Haier

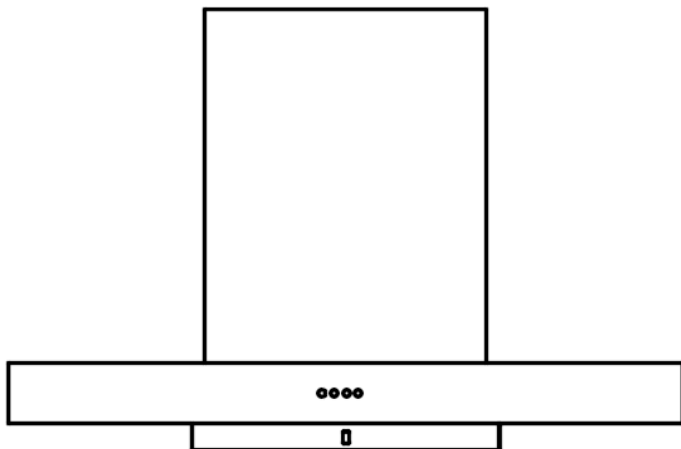

**IT9001**

# **Cooker Hood**

---

**INSTALLATION AND USER'S MANUAL**

# SAFETY PRECAUTION

---

- **I** mportant! Always switch off the electricity supply at the mains during installation and maintenance such as light bulb replacement.
- **T** he cooker hood must be installed in accordance with the installation instructions and all measurements followed.
- **A** ll installation work must be carried out by a competent person or qualified electrician.
- **P** lease dispose of the packing material carefully. Children are vulnerable to it.
- **P** ay attention to the sharp edges inside the cooker hood especially during installation and cleaning.
- **W** hen installing the cooker hood, make sure that the following recommended distances between the top of cooker and the lowest part of the cooker hood are observed:  
Gas cookers: 70 cm  
Electric cookers: 70 cm  
Coal or oil cookers: 80 cm
- **M** ake sure the ducting has no bends sharper than 90 degrees as this will reduce the efficiency of the cooker hood.
- **C** ooker hood is for domestic use only.
- **A** lways put lids on pots and pans when cooking on a gas cooker.
- **D** o not try to use the cooker hood without the grease filters or if the filters are excessively greasy!
- **W** hen in extraction mode, air in the room is being removed by the cooker hood. Please make sure that proper ventilation measures are being observed. The cooker hood removes odours from room but not steam.
- **T** here shall be adequate ventilation of the room when the range hood is used at the same time as appliances burning gas or other fuels.
- **D** o not install above a cooker with a high level grill.
- **D** o not leave frying pans unattended during use because overheated fats or oils might catch fire.
- **N** ever leave naked flames under the cooker hood.
- **I** f the cooker hood is damaged, do not attempt to use.
- **I** f the supply cord is damaged, it must be replaced by the manufacturer, its service agent or similarly qualified persons in order to avoid a hazard.
- **T** his appliance can be used by children aged from 8 years and above and persons with reduced physical, sensory or mental capabilities or lack of experience and knowledge if they have been given supervision or instruction concerning use of the appliance in a safe way and understand the hazards involved. Children shall not play with the appliance. Cleaning and user maintenance shall not be made by children without supervision.

# SAFETY PRECAUTION

---

- **Caution:** The appliance and its accessible parts can become hot during operation. Be careful to avoid touching the heating elements. Children younger than 8 years old should stay away unless they are under permanent supervision.
- There shall be adequate ventilation of the room when the range hood is used at the same time as appliances burning gas or other fuels.
- There is a fire risk if cleaning is not carried out in accordance with the instructions.
- Do not flambé under the cooker hood.
- **CAUTION:** Accessible parts may become hot when used with cooking appliances.
- The air must not be discharged into a flue that is used for exhausting fumes from appliances burning gas or other fuels.
- The minimum distance between the supporting surface for the cooking vessels on the hob and the lowest part of the range hood.  
(When the range hood is located above a gas appliance, this distance shall be at least 70cm.)
- Regulations concerning the discharge of air have to be fulfilled.
- **C**lean your appliance periodically by following the method given in the chapter MAINTENANCE.
- **W**arning: Failure to install the screws or fixing device in accordance with these instructions may result in electrical hazards

**Regarding the instructions method of fixing for the fixed appliance and how the appliance is to be fixed to its support, thanks to refer to the section “INSTALLATION”.**

**The bulbs are not replaceable.**

**The plug must be remained easily accessible after installation of the appliance.**

## Important

This instruction manual is designed to provide you with all required instructions related to the installation, use and maintenance of the appliance. In order to operate the unit correctly and safety, please read this instruction manual carefully before installation and usage.

We can not be held responsible for injuries or losses caused by incorrect use or installation of this product. Please note that we reserve the right to invalidate the guarantee supplied with this product following incorrect installation or misuse of the appliance or use in a commercial environment.

Under no circumstances should any external covers be removed for servicing or maintenance except by suitably qualified personnel

### Appliance information:

Please enter the details on the appliance rating plate below for reference, to assist we Customer Care in the event of a fault with your appliance and to register your appliance for guarantee purposes.

Appliance Model

Serial Number

# Parts identification



## Parts Name

- (1) Extraction hood
- (2) Chimney section (including upper and lower parts)
- (3) Hose connector
- (4) Upper wall bracket
- (5) Lower wall bracket
- (6)  $\varnothing$  4mm x 10mm Screw (6 pcs)
- (7) Washer (2 pcs)
- (8) Wall plug (8 pcs)
- (9)  $\varnothing$  4mm x 35mm Screw (8 pcs)
- (10) Exhaust hose ( $\varnothing$ 15cm)
- (11) Carbon filter (required for circulating air mode)
- (12) Cable tie

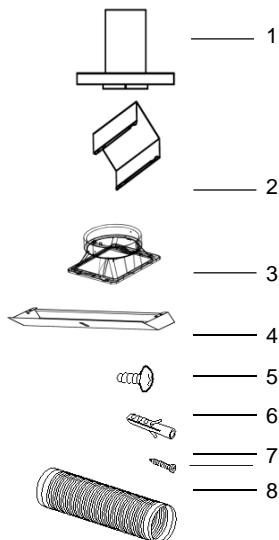

## Technical specifications

<b>Model</b>	<b>CXW-200-IT9001</b>
<b>Voltage</b>	220-240V~50Hz
<b>Product dimension</b>	90x49x55
<b>WxDxH(in cms)</b>	

<b>Wattage(Total)</b>	202W
<b>Motor</b>	200W
<b>Filter</b>	* 1xAluminium Filter
<b>Light</b>	1x2W LED lights
<b>Noise Level</b>	68dB
<b>Speed control</b>	2 Speed control
<b>Type of switch</b>	Electronic switchl

# Installation (for venting outside)

When the cooker hood is to be installed above an electric hob or a gas hob, the minimum distance between the hob and cooker hood must exceed 700mm.

If the instructions for installation for the gas hob specify a greater distance, this has to be taken into account.

The height should be measured from the top of the burners.

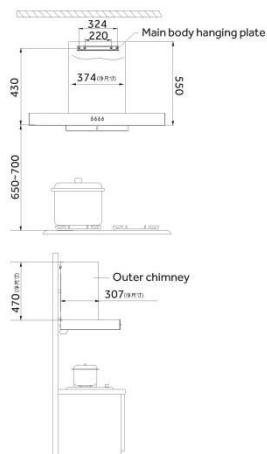

# Installation (for venting outside)

Tools required

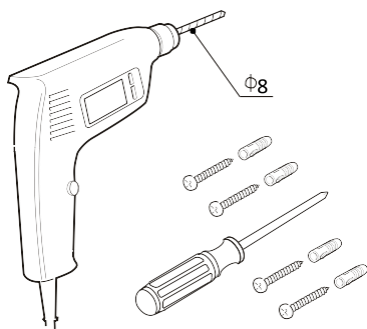

Fig. 5

Mark wall as required (see Fig. 6)

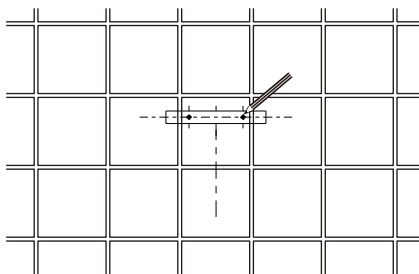

Fig. 6

Drill holes for mounting the body.

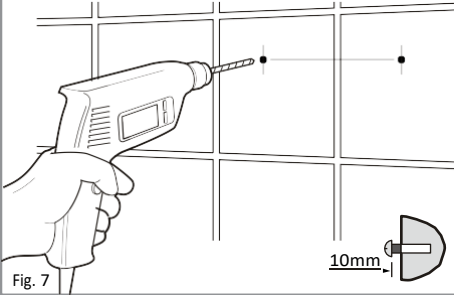

Fig. 7

Fix support plate on the wall by screws with expanding plugs.

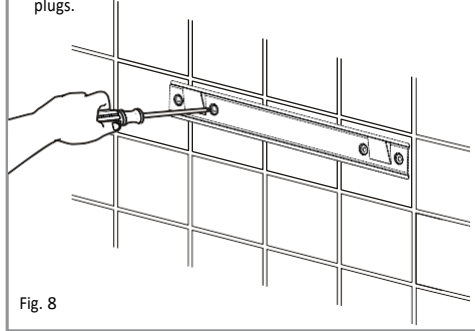

Fig. 8

Secure hood (tighten all screws).

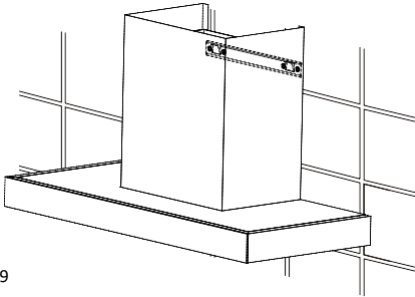

Fig. 9

Fit ducting adaptor.

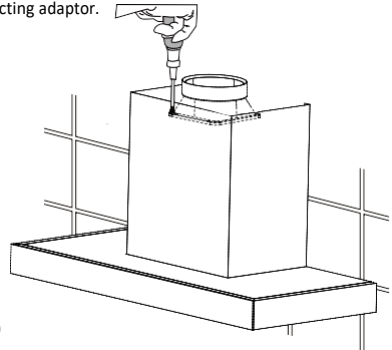
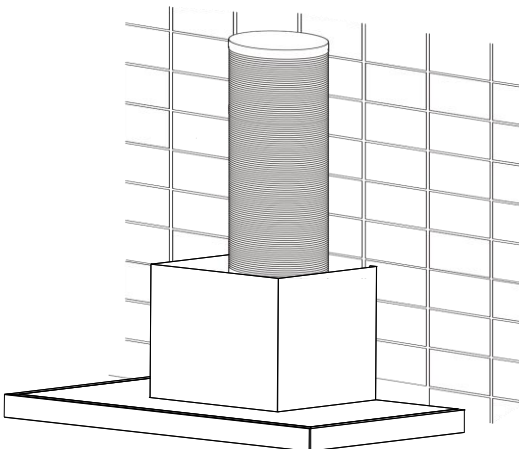

Fig. 10

**IMPORTANT SAFETY WARNING: ONLY USE THE SCREWS PROVIDED WITH THE RANGE HOOD TO MOUNT THE DUCTING ADAPTOR. THE USE OF LONGER SCREWS MAY CAUSE DAMAGE TO THE INTERNAL WIRING WHICH WILL NOT BE COVERED BY THE WARRANTY.**

Fix ducting (seal joint by 3 pieces ST3X8).







---

If you do not have an outlet for exhausting air, the exhaust hose (part [10]) is not required, and the installation is similar to the one shown in the section "Installation (for venting outside)".

Air is vented back into the kitchen through the opening of the cooker hood, this circulating air mode requires the use of the carbon filter (part [11]) to remove odors.

**Attention** -Remove the plastic packaging bag from the carbon filter before use. For venting outside, carbon filter is not required.

To ensure best performance of your cooker hood, you should replace the carbon filter every 2-3 months, depending on the frequency of use. Check with your local retailer or dealer to buy new carbon filters for replacement.

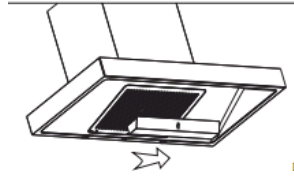

8









# Using your Cooker hood

For best performance, you should switch on the extractor 15 minutes before starting to cook and leave it to run for approximately 15 minutes after the end of cooking.







Fig. 13



## ON/OFF Key/Delay Timer:

- Press the  key to turn on/o the extractor. If the extractor is turned on, the delay timer can be activated by pressing the  again. The display will show the symbol  flashing for 4 seconds. By pressing the keys  or , the delay timer can be adjusted (max. 9 minutes). In order to deactivate the timer delay, press the  key again.



## Clock Setting

- To set the clock on your extractor, press and hold the  key for 2 seconds. The clock display will flash. Use  or  keys to set the hour, press  key to set after which you can adjust the minutes. Once set, press  key to confirm. Please note, the clock will return to its previous setting if no key is pressed for 5 seconds whilst setting the time.

## Adjusting the Fan Speed

- Once the extractor is turned on, press the  key to set the fan motor to high speed. When pressed again, it will reduce the fan speed from high to medium, to low and finally o .  
Once the extractor is turned on, press the  key to set the fan motor to high speed. When pressed again, it will reduce the fan speed from high to medium, to low and finally o .

## Light Key

- Press the  key to turn on/o the lights. When the lights are on, the display will show the symbol  .

# Care and Maintenance

---

**IMPORTANT : DO NOT PERFORM MAINTENANCE OR CLEANING OF THE COOKER HOOD WITHOUT FIRST SWITCHING OFF THE ELECTRICITY SUPPLY.**

## **Cleaning**

You should use a nonabrasive cleaner. Any abrasive cleaner (including Cif) will scratch the surface and could erase the control panel markings.

You can clean your cooker hood effectively by simply using a dilute solution of water and mild detergent and then dry it with a clean cloth.

## **Cleaning the grease filter**

The grease filter should be kept clean to minimise the risk of fire.

At least once a month you should remove and clean the grease filter with hot soapy water. You can also wash the grease filter in a dishwasher, ensuring that you place it in an upright position to prevent damage from other items in the dishwasher.

To remove the grease filter, push in the button on the handle and then pull down on the filter at the front as shown in Fig. 14.1.

After rinsing and drying the filter, replace it as shown in Fig. 14.2.

## **Please note:**

Cleaning the grease filter in the dishwasher may lead to discoloration. This is normal and does not constitute a fault with the appliance.



# Information for cooker hood

---

## ENVIRONMENTAL PROTECTION:



This product is marked with the symbol on the selective sorting of waste electronic equipment. This means that this product must not be disposed of with household waste but must be supported by a system of selective collection in accordance with Directive 2002/96/EC. It will then be recycled or dismantled to minimize impacts on the environment, electrical and electronic products are potentially dangerous for the environment and human health due to the presence of hazardous substances. For more information, please contact your local or regional authorities.

### Note:

The following shows how to reduce total environmental impact (e.g. energy use) of the cooking process).

- (13) Install the cooker hood in a proper place where there is efficient ventilation.
- (14) Clean the cooker hood regularly so as not to block the airway.
- (15) Remember to switch off the cooker hood light after cooking.
- (16) Remember to switch off the cooker hood after cooking.

### Information for dismantling

Do not dismantle the appliance in a way which is not shown in the user manual. The appliance could not be dismantled by user. At the end of life, the appliance should not be disposed of with household waste. Check with you Local Authority or retainer for recycling advice.

# 6. Troubleshooting

Failure	Root cause	Corrective action
No power	<ol style="list-style-type: none"> <li>1. Not plug-in or poor plug-in.</li> <li>2. Power socket is no power.</li> <li>3. Power supply dose not connect with fuse or fuse broken.</li> </ol>	<ol style="list-style-type: none"> <li>1. Plug-in perfect.</li> <li>2. Connect with power supply or contact electrician for after service.</li> <li>3. Replace fuse or call electrician for after service.</li> </ol>
No work	<ol style="list-style-type: none"> <li>1. Power supply does not work or voltage is not stable.</li> <li>2. No operation on fan speed button.</li> </ol>	<ol style="list-style-type: none"> <li>1. Make sure power supply works normally or call electltricial for after service.</li> <li>2. Press on fan speed button.</li> </ol>
Light not on	<ol style="list-style-type: none"> <li>1. No operation on light button.</li> <li>2. The lamp is burnt down.</li> </ol>	<ol style="list-style-type: none"> <li>1. Press on light button.</li> <li>2. Replace lamp (please call service center)</li> </ol>
Main body vabration	<ol style="list-style-type: none"> <li>1. Main body mounting is not stable.</li> <li>2. Defective installation for fan.</li> <li>3. Defective fan</li> </ol>	<ol style="list-style-type: none"> <li>1. Make sure main body mounting is stable enough.</li> <li>2. Install fan correctly.</li> <li>3. Replace fan (please call service center</li> </ol>
Poor suction	<ol style="list-style-type: none"> <li>1. When use hood, the kitchen door and window are opened too much or close directly.</li> <li>2. Hood installation height is out of the range.</li> <li>3. Hose is too long or too much bend of hose.</li> </ol>	<ol style="list-style-type: none"> <li>1. Open or close door or window to adjust suction.</li> <li>2. Adjust hood installation height as user manual.</li> <li>3. Reduce length and bend of hose.</li> <li>4. Enlarge common venting hole diameter to make sure the damper of the hood can be closed exactly.</li> </ol>

## 1. Oil cup.

Remove oil cup from card slot based on horizontal.

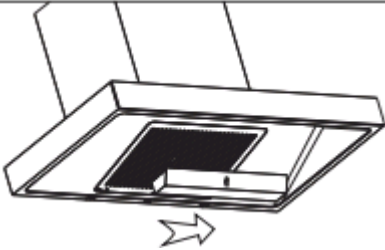

## 2. Filter

Remove screws to take out filter.



## 3. Hand-fasten nut

Clockwise rotate the nut to remove it.



## 4. Fan



Remove fan.



## 5. Chimney

Remove 4 screws, take out chimneys.



## 6. Cover sheet

Remove 4 screws to take out cover sheet.

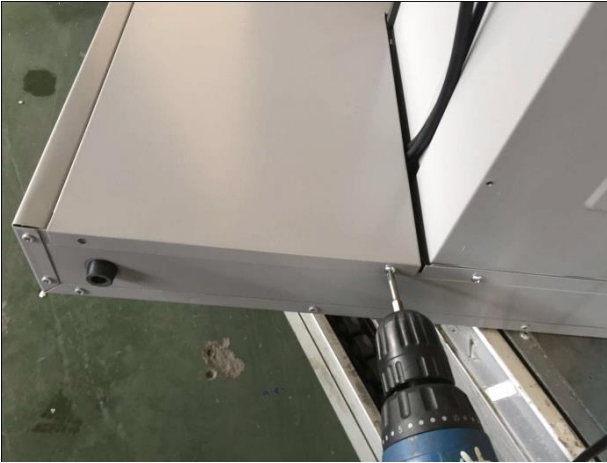

7. Maintenance cover

Remove 12 screws to take out maintenance cover. Then repair fan and motor.



8. Remove 8 screws from damper and 4 screws from air outlet. Then from reverse side of body to remove one M5 screw.





## 9. LED light and switch control wire

Use flat screwdriver to remove LED light. Disconnect all responding wire connectors for replacement.



Wiring Diagram

